	Datenblatt / Data Sheet	Seite 1 von 2
	Hochdruck – Fitting	DB 2.421
	High Pressure - Fitting	Revision 1.0
Übergang / Connection BSP Male		

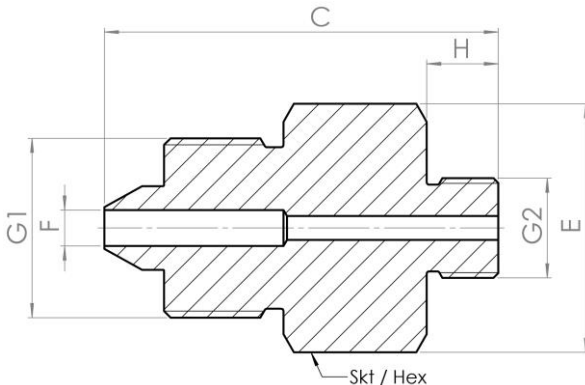

Übergang , M16 x 1,5 / 9/16"-18 UNF, HD-Rohr 6mm / 6,35mm (1/4")
 Connection , M16 x 1,5 / 9/16"-18 UNF, HD-Tube 6mm / 6,35mm (1/4")

Bezeichnung Typ	Abmessungen (mm) Dimensions (mm)									Betriebsdruck Working Pressure (bar)
	A	B	C	D	E	F	G1	G2	H	
221/295-016 241/295-016			49		SW22	2,2	M16 x 1,5 9/16"-18 UNF	G 1/4"	17	1600
221/296-010 241/296-010			49		SW22	2,2	M16 x 1,5 9/16"-18 UNF	G 3/8"	17	1000
221/297-007 241/297-007			49		SW22	2,2	M16 x 1,5 9/16"-18 UNF	G 1/2"	17	700

Übergang , M20 x 1,5 / 3/4"-16 UNF, HD-Rohr 10mm / 9,52mm (3/8")
 Connection , M20 x 1,5 / 3/4"-16 UNF, HD-Tube 10mm / 9,52mm (3/8")

Bezeichnung Typ	Abmessungen (mm) Dimensions (mm)									Betriebsdruck Working Pressure (bar)
	A	B	C	D	E	F	G1	G2	H	
222/295-016 242/295-016			52		SW22	5,0	M20 x 1,5 3/4"-16 UNF	G 1/4"	12	1600
222/296-010 242/296-010			52		SW22	5,0	M20 x 1,5 3/4"-16 UNF	G 3/8"	12	1000
222/297-007 242/297-007			52		SW27	5,0	M20 x 1,5 3/4"-16 UNF	G 1/2"	14	700

	Datenblatt/ Data Sheet	Seite 2 von 2
	Hochdruck – Fitting	DB 2.421
	High Pressure - Fitting	Revision 1.0
Übergang / Connection BSP Male		

Übergang , M30 x 2,0 / 1-1/8"-12 UNF, HD-Rohr 14mm / 14,3mm (9/16")
 Connection , M30 x 2,0 / 1-1/8"-12 UNF, HD-Tube 14mm / 14,3mm (9/16")

Bezeichnung Typ	Abmessungen (mm) Dimensions (mm)									Betriebsdruck Working Pressure (bar)
	A	B	C	D	E	F	G1	G2	H	
223/295-016 243/295-016			66		SW36	5,0	M30 x 2,0 1-1/8"-12 UNF	G 1/4"	12	1600
223/296-010 243/296-010			66		SW36	6,0	M30 x 2,0 1-1/8"-12 UNF	G 3/8"	12	1000
223/297-007 243/297-007			66		SW36	8,0	M30 x 2,0 1-1/8"-12 UNF	G 1/2"	12	700